

INSTALLATION INSTRUCTIONS

For Model 2302-84 (New. 11/26/2015)

READ AND SAVE THESE INSTRUCTIONS

WARNING! SHUT POWER OFF AT FUSE OR CIRCUIT BREAKER.

AVERTISSEMENT! COUPER LE COURANT AU NIVEAU DES FUSIBLES OU DU DISJONCTEUR.

PREPARING FOR INSTALLATION (Fig. 1)

1. Shut off the power at the fuse box or circuit breaker. If necessary, remove the old fixture, including the mounting hardware.
2. Carefully unpack your new fixture, lay out all parts on a clear area. Take care not to lose any small parts necessary for installation.
3. Attach the circular strap (A) to the outlet box using the mounting screws (B) (Size: #8-32N*L0.5"). The side of the circular strap (A) marked "GND" must face out.
4. Thread the studs (C) into the pre-drilled holes of the circular strap (A), spaced the same distance apart as the holes in the back plate (D).

CONNECTING THE WIRES (Fig. 2)

5. At this point, connect the fixture wires to outlet box wires as shown in Fig. 2, making sure that all wire connectors are secured. If your outlet box has a ground wire (green or bare copper), connect the fixture's ground wire to it. Otherwise, connect the fixture's ground wire directly to the circular strap (A) using the green screw provided. After wires are connected, tuck them carefully inside the outlet box.

COMPLETING THE INSTALLATION (Fig. 1)

6. Align back plate (D) onto studs (C) and secure with two ball nuts (E).
7. Install light bulb(s) (not included) in accordance with the fixture's specification. **(DO NOT EXCEED THE MAXIMUM WATTAGE RATING!) (NE PAS DEPASSER LA PUISSANCE NOMINALE MAXIMALE!).**
8. Place glass shade (H) through the bulb (G) and tighten the glass shade onto socket cup (F) by twisting it clock wise.

Your installation is now complete. Return power to the outlet box and test the fixture.

Note: Illustration (Fig. 1) on this manual is for installation purposes only. It may or may not be identical to the fixture purchased.

Fig.1

Set# A-020

- Circular Strap
- Ground Screw
- Mounting Screw*2

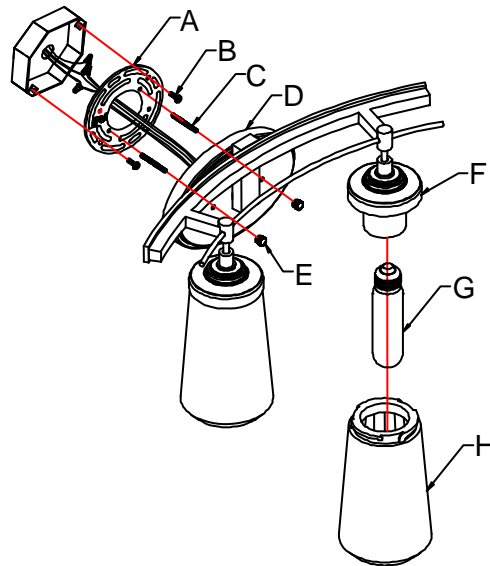

Fig.2

